

Labochema Eesti OÜ Sooduspakkumine

Bochem® terasest laboritarvikud Suur ühistellimus Tarne 2022 I kvartal

Double Spatula, 18/10 roostevaba teras

- Autoklaavitavad
- Hea kuumataluvus, kemikaalidele vastupidav
- Puuduvad magneetilised omadused



Tootekood	A mm	a mm	B mm	D mm	Hind	Soodushind
3100	130	40	9	3	1,86 €	1,56 €
3101	150	45	9	3,5	1,86 €	1,56 €
3102	185	50	9	3,5	2,27 €	1,86 €
3103	210	60	11	4	2,67 €	2,16 €
3104	250	70	11	4	2,82 €	2,31 €
3105	300	75	16	6	4,55 €	3,65 €
3106	350	85	16	6	5,05 €	4,10 €
3107	400	100	16	6	6,96 €	5,60 €
3108	500	100	20	8	7,91 €	6,34 €

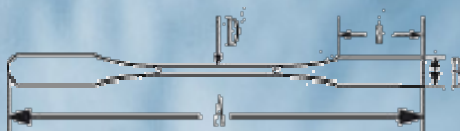

Mikro-spaatel, 18/10 roostevaba teras

Tootekood	A mm	a mm	B mm	D mm	Hind	Soodushind
3010	100	30	2	1	1,94 €	1,56 €
3011	130	40	2	1	2,22 €	1,79 €
3012	150	40	2	1	2,20 €	1,79 €
3013	100	35	3	1,5	1,94 €	1,56 €
3014	130	40	3	1,5	2,22 €	1,79 €
3015	150	40	3	1,5	2,20 €	1,79 €
3016	100	35	4	2	1,94 €	1,56 €
3017	130	40	4	2	2,22 €	1,79 €



3018	150	40	4	2	2,20 €	1,79 €
3019	185	50	4	2	2,50 €	2,01 €
3020	100	35	5	2	1,94 €	1,56 €
3021	130	40	5	2	2,22 €	1,79 €
3022	150	40	5	2	2,20 €	1,79 €
3023	185	50	5	2	2,50 €	2,18 €
3024	210	55	5	2	2,65 €	2,16 €
3025	150	40	6	2	2,20 €	1,79 €
3026	185	50	6	2	2,50 €	2,01 €
3027	210	55	6	2	2,65 €	2,16 €
3028	150	40	9	3	2,20 €	1,79 €
3029	185	50	9	3	2,50 €	2,01 €
3030	210	55	9	3	2,65 €	2,16 €



Lusikas-spaatel, 18/10 roostevaba teras

- Autoklaavitav
- Kemikaalidele vastupidav, hea kuumataluvus
- Kergelt ja kiirelt puhastatav



Tootekood	A mm	a mm	b mm	D mm	FxE mm	Hind	Soodushind
3470	120	35	10	5	30 x 22	5,90 €	4,63 €
3471	150	40	10	5	30 x 22	5,20 €	4,93 €
3472	180	50	12	5	40 x 29	6,63 €	5,30 €
3473	210	50	12	5	40 x 29	7,20 €	5,83 €
3474	250	70	14	5	48 x 35	7,49 €	5,98 €
3475	300	70	14	5	48 x 35	8,02 €	6,42 €
3380	150	-	-	1	30 x 15	2,27 €	1,86 €

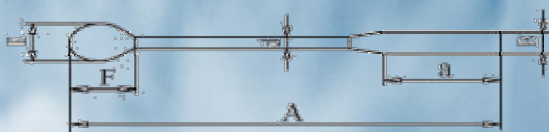

Pintsetid, tõmbi otsaga

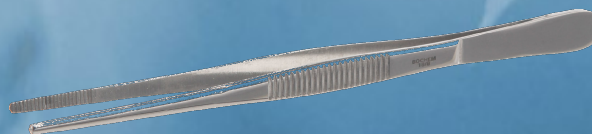

Tootekood	Pikkus mm	Hind	Soodushind
1000	105	3,95 €	3,20 €
1001	115	4,09 €	3,35 €
1002	130	4,50 €	3,65 €
1003	145	4,78 €	3,88 €
1004	160	4,90 €	3,95 €

1005	200	8,40 €	6,72 €
1006	250	8,91 €	7,09 €
1007	300	10,09 €	8,07 €

Pintsetid, terava otsaga



Tootekood	Pikkus mm	Hind	Soodushind
1010	105	4,50 €	3,65 €
1011	115	4,60 €	3,73 €
1012	130	4,92 €	3,95 €
1013	145	5,30 €	4,25 €
1014	160	6,43 €	5,23 €
1015	200	8,79 €	7,02 €



Pintsetid, kumera otsaga

Tootekood	Pikkus mm	Hind	Soodushind
1019	105	5,02 €	4,03 €
1020	115	5,20 €	4,18 €
1021	130	5,39 €	4,33 €
1022	145	5,51 €	4,40 €
1023	160	6,67 €	5,38 €
1024	200	9,11 €	7,24 €

Käärid

- Sirged, roostevabast terasest, kemikaalikindlad
- Tüüp 2: üks tõmp, üks terav ots

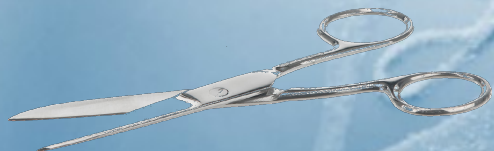

Tootekood	A mm	a mm	Hind	Soodushind
4000	100	30	6,76 €	5,45 €
4001	115	45	7,29 €	5,83 €
4002	130	50	7,83 €	6,27 €
4003	145	60	8,39 €	6,72 €
4004	150	60	9,22 €	7,32 €
4005	165	70	9,87 €	7,92 €
4006	180	80	10,74 €	8,59 €

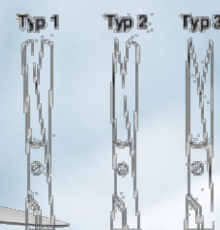
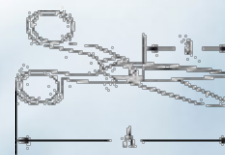

Käärid

- Sirged, roostevabast terasest, kemikaalikindlad
- Tüüp 1 – mõlemad tõmbid otsad
- Tüüp 2 – üks tõmp, üks terav ots
- Tüüp 3 – mõlemad teravad otsad

Tootekood	A mm	a mm	Tüüp	Hind	Soodushind
4100	130	40	2	5,98 €	4,78 €
4101	145	45	2	6,61 €	5,30 €
4102	155	55	2	6,99 €	5,60 €
4103	130	40	3	5,98 €	4,78 €
4104	145	45	3	6,61 €	5,30 €
4105	155	55	3	6,99 €	5,60 €
4106	130	40	1	5,98 €	4,78 €
4107	145	45	1	6,61 €	5,30 €
4108	155	55	1	6,99 €	5,60 €

Korvid

- 18/10 roostevabast terasest,
- elektrolüütiliselt poleeritud
- anti-magnetilised
- võrgu suurus 8x8x1 mm

Tootekood	A mm	B mm	C mm	Hind	Soodushind
10020	100	100	100	37,83 €	29,96 €
10021	120	120	100	38,97 €	30,94 €
10022	120	120	120	43,99 €	34,83 €
10023	150	100	100	48,37 €	38,27 €
10024	140	140	140	50,07 €	39,68 €
10025	150	150	150	72,60 €	57,47 €
10026	160	160	160	57,70 €	45,66 €
10027	200	150	150	60,76 €	48,13 €
10028	180	180	150	63,92 €	50,60 €
10029	180	180	180	65,94 €	52,24 €
10030	200	200	150	81,83 €	64,80 €
10031	200	200	200	73,15 €	57,92 €
10032	250	150	150	108,36 €	86,71 €
10033	300	200	150	106,66 €	85,21 €
10071	400	300	200	179,25 €	142,77 €
10073	500	300	250	214,93 €	170,43 €

10076	600	400	300	226,02 €	179,40 €
-------	-----	-----	-----	----------	-----------------

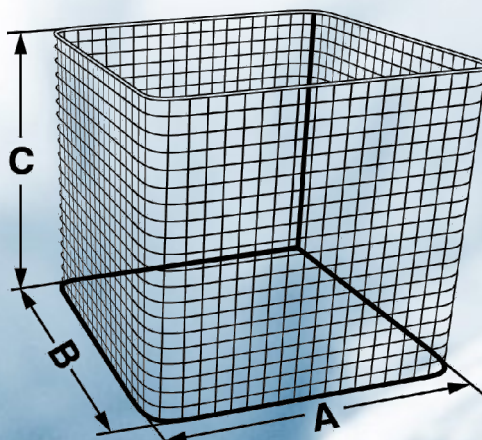
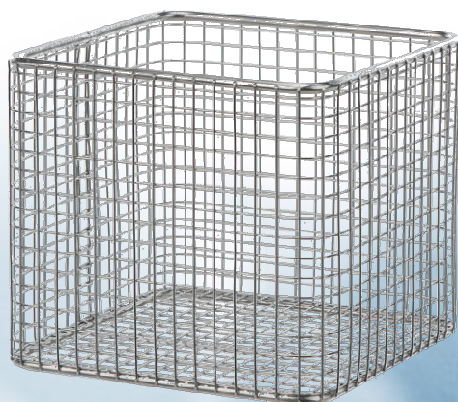

Värvitud terasest tugialused

- 1 reguleeritav jalg
- M10 keere

Tootekood	A mm	B mm	C mm	Kg	Hind	Soodushind
5030	180	100	6	0,8	15,06 €	11,96 €
5031	210	130	6	1,3	17,38 €	13,82 €
5032	250	160	6	2,0	24,50 €	19,43 €
5033	300	150	6	2,2	27,66 €	21,97 €
5034	315	200	6	3,0	37,67 €	29,90 €
5035	210	130	8	1,8	21,64 €	17,19 €
5036	250	160	8	2,6	30,13 €	23,92 €
5037	315	200	8	4,0	47,00 €	37,22 €
5038	315	200	10	5,0	59,38 €	47,01 €

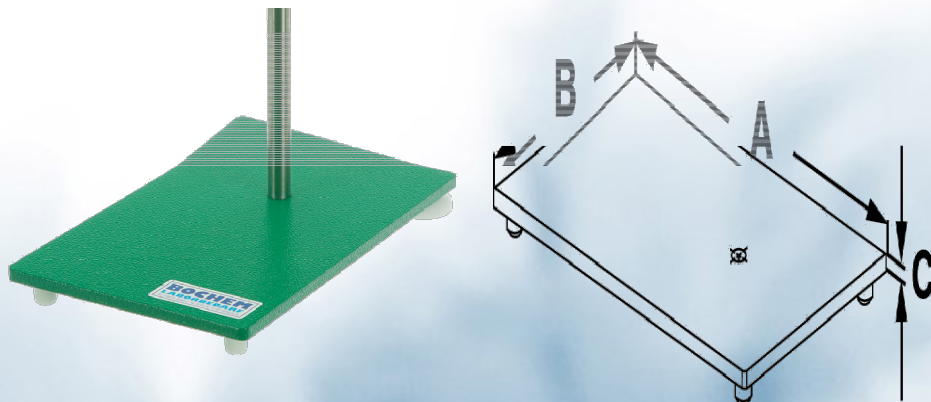

Vardad tugialustele
- Keere M10

Tootekood	A mm	D mm	Materjal	Hind	Soodushind
5150	500	12	Tsingitud teras	8,23 €	6,57 €
5151	600	12	Tsingitud teras	8,79 €	7,02 €
5152	750	12	Tsingitud teras	10,15 €	8,14 €
5153	1000	12	Tsingitud teras	11,99 €	9,56 €
5154	1250	12	Tsingitud teras	14,35 €	11,43 €
5155	1500	12	Tsingitud teras	16,36 €	13,07 €
5130	500	12	Alumiinium	7,64 €	6,12 €
5131	600	12	Alumiinium	8,65 €	6,87 €
5132	750	12	Alumiinium	10,00 €	7,99 €
5133	1000	12	Alumiinium	13,00 €	10,31 €

Muhv, kroomitud malm (DIN 12895)
- Keere M8

Tootekood	d mm	Hind	Soodushind
5360	16,5	6,65 €	5,30 €
5359	20,0	11,94 €	9,48 €
5369	36,0	18,74 €	14,86 €

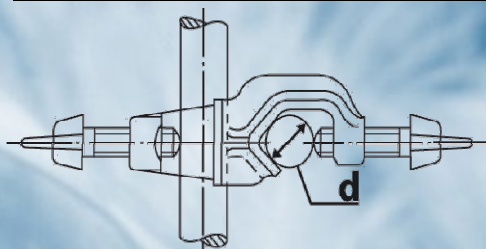
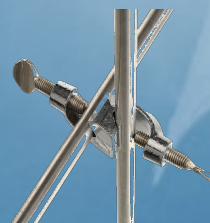

Käpad (DIN 12894)
- Korgiga kaetud harud

Tootekood	A mm	D mm	d mm	Materjal	Hind	Soodushind
5461	150	12	25	Kroomitud	10,65 €	8,52 €
5462	150	12	40	Kroomitud	11,72 €	9,33 €
5463	150	12	60	Kroomitud	13,20 €	10,46 €
5464	180	12	80	Tsingitud	15,08 €	11,96 €
5480	180	12	100	Tsingitud	17,28 €	13,75 €
5481	180	12	120	Tsingitud	19,64 €	15,54 €
5482	180	12	150	Tsingitud	22,08 €	17,49 €

Lab-Jacks, 18/10 roostevaba teras

Tüüp 1: reguleerimiskruviga

Tüüp 2: reguleerimiskruvi mutrivõtmega (komplektis)

Tüüp: MAXI

- 30% kõrgem

- Roostevabast terasest

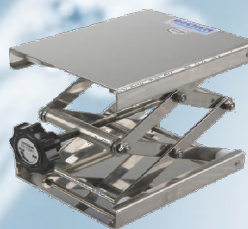

Koormus (Kg max dünaamiline) vastavalt DIN 12 897

Tüüp 1

Toote-kood	A mm (pikkus)	B mm (laius)	C/min	C/max	Kg max dyn	Kg max stat	Tüüp	Hind	Soodushind
11115	100	100	55	120	5	10	1	151,65 €	120,34 €
11120	160	130	60	275	7	30	1	162,64 €	130,06 €
11130	200	200	60	275	7	30	1	195,63 €	155,48 €
11140	240	240	60	275	7	30	1	208,77 €	165,94 €
11180	300	300	90	470	12	60	2	1087,88	867,10 €
11190	400	400	90	470	15	60	2	1336,94	1068,92 €
11122	160	130	75	400	7	30	MAXI	199,98	159,21 €
11132	200	200	75	400	7	30	MAXI	240,66 €	191,36 €

(Mutrivõti eraldi tellimisel: 11088 – 33,18 € (kampaniahind!))

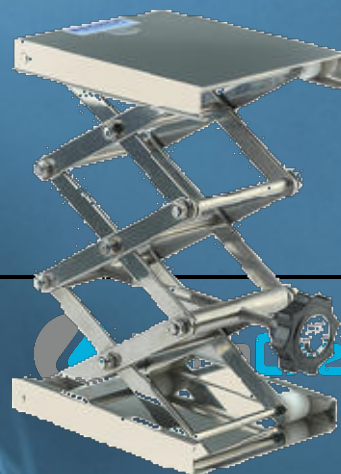
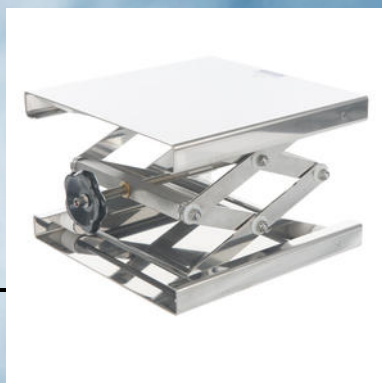

Tüüp 2

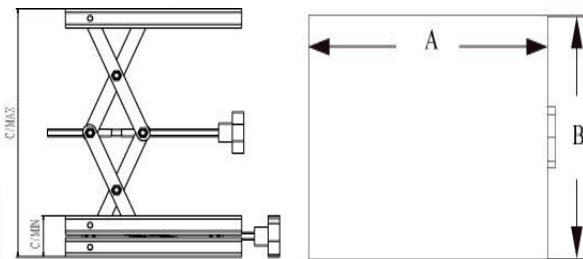

Tüüp MAXI

Labori käru

- 18/10 roostevaba teras
- Kaks lukustatavat juhtratast
- Plaadi mõõdud 800 x 500 mm
- 25 kg max / plaadi kohta

Tüüp 1: 2 plaati

Tüüp 2: 3 plaati

Tootekood	A mm	B mm	C mm	C1 mm	Kg max	Tüüp	Hind	Soodushind
11430	900	600	940	275	50	1	178,83 €	163,87 €
11431	900	600	940	275	75	190,72 €	174,22 €	

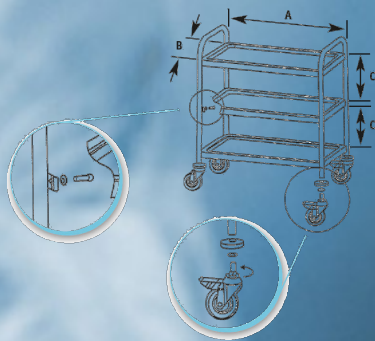

Lahkamisnõelad



Tootekood	Kirjeldus	Kogus laos	Hind	Soodushind
12030	Roostevabast terasest, pikkus 140mm, <i>sharp</i>	5	7,01 €	5,60 €
12020	Roostevabast terasest, pikkus 140mm, <i>lancet</i>	1	7,67 €	6,12 €

Tiigitangid

- 18/10 roostevabast terasest,
- elektrolüütiliselt poleeritud
- anti-magnetilised
- korrosioonikindlad, autoklaavitavad, hea kuumataluvus

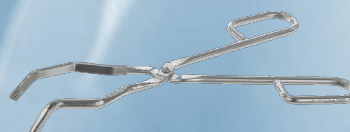

Tootekood	Pikkus	Hind	Soodushind
2099	160 mm	5,59 €	4,48 €
2100	200 mm	5,95 €	4,83 €
2101	220 mm	6,03 €	4,90 €
2102	250 mm	6,48 €	5,26 €
2103	300 mm	6,64€	5,40 €
2104	400 mm	15,58 €	12,66 €

Küsi pakkumist ka teistele Bochemi toodetele:
<http://www.bochem.com/en/Products.html>

Hindadele lisandub käibemaks!

Juhul kui pakkumises olevad tooted ei kuulu teie tegevusvaldkonda, kuid teate kedagi, kes neid kasutab, siis saatke see pakkumine edasi kõigile, kellele see huvi võiks pakkuda.

Hinnad kehtivad kuni 17.12.2021

Labochema Eesti OÜ
Riia 142
5 411 Tartu
Tel 7311131
info@labochema.ee

www.labochema.ee

